

***AnyTone***<sup>®</sup>  
*We only do best radio!*

Qixiang Electron Science & Technology Co., Ltd.  
[www.qxdz.cn](http://www.qxdz.cn)

# AnyTone®



ISO 9001  
ISO 14001



## AT-398UV

DUAL BAND HANDHELD RADIO



INSTRUCTION MANUAL



## THANK YOU!

*AnyTone*® transceiver will provide you with reliable, clear and efficient communication service. The transceiver introduces innovative DSP digital signal processing technology, high degree integration, it is including kinds of professional function, best stability and great reliability as well as exterior smooth lines, novel, fashionable, sturdy and durable.

The transceiver includes plenty of TX, RX channels, as well as UU,VV and UV standby modes which is able to realize cross band function, frequency hopping function, dual PTT function. 51 groups of CTCSS encode/decode and 1 group of user-defined CTCSS encode/decode, 1024 groups of DCS encode/decode, 5TONE/2TONE/MSK/DTMF encode/decode, built-in radio functions, etc..It is a meticulous build functional and Multi frequency band radio for radio amateur and commercial use.

### Versions

To meet different requirements of users, we provide A,B,C,D four versions with different frequency bands, convenient for user optional.

Version A: Dual frequency, dual standby, dual display, dual band, single receive channel.

Version B: Dual frequency, dual standby, dual display, tri band, 350-390MHz is able to combine with UHF or VHF be dual frequency to receive signal at same time.

Version C: Dual frequency, dual standby, dual display, dual band, dual receive channel, cross-band repeater function.

Version D: Dual frequency, dual standby, dual display, dual band, dual receive channel, cross band-repeater function, MSK function, 2TONE/MSK encode/decode.

## MODELS APPLY TO THIS MANUAL

AT-398UV FM transceiver

AT-398UV(Version A,C,D) programming software: QPS398UV

AT-398UV(Version B) programming software: QPS398UV\_B

## PROGRAM CAUTIONS

When programming the transceiver, **read the factory initial data first**, then rewrite the frequency and signaling etc., other wise errors may occur because of different frequency ranges involved.

## CAUTIONS

*AnyTone*<sup>®</sup> transceiver is excellent designed with advanced technology. The following tips will be helpful for you in performing your obligation under warranty and understanding the safety of transceiver usage.

- 1.Keep the transceiver and accessories away from children.
- 2.Please do not try to open or modify the transceiver without permission, non-professionals operation may also cause damage.
- 3.Please use assorted battery and charger to avoid damage.
- 4.Please use assorted antenna to ensure the communication distance.
- 5.Please avoid exposing the radio under the sunshine for a long time or storing it in too hot places. High temperature will shorten the life of electronic devices.
- 6.Please avoid storing the radio in the dusty, dirty and damp areas.
- 7.Please keep the radio dry. Do not wash radio with ardent chemicals and detergents.
- 8.Do not transmit without antenna.
- 9.When using this transceiver, we recommend transmitting for 1 minute then receiving for 4 minutes. continuously transmitting for long time or working in high power will heat the back of the transceiver. Do not place the transceiver's hot back close to any plastics.
- 10.If any abnormal smell or smoke coming from the transceiver, please turn off the power instantly and take off the battery and its case. Then contact local *AnyTone*<sup>®</sup> dealers.

### NOTE:

All the above tips apply for your *AnyTone*<sup>®</sup> transceivers' accessories. If any device can not operate normally, please contact with local *AnyTone*<sup>®</sup> dealers.

If you use any accessories made by other companies, *AnyTone*<sup>®</sup> company does not guarantee the operability and safety of the transceiver.

# ◦ TABLE OF CONTENTS

<b>UNPACKING</b> .....	01
Supplied Accessories .....	01
<b>STANDARD ACCESSORIES/ADDITIONAL ACCESSORIES</b> .....	02
Standard Accessories.....	02
Additional Accessories.....	02
<b>OPERATION MODE (AMATEUR TRANSCEIVER OR PROFESSIONAL TRANSCEIVER)</b> .....	03
<b>WORKING MODE (AMATEUR TRANSCEIVER OR PROFESSIONAL TRANSCEIVER)</b> .....	04
<b>BATTERY INFORMATION</b> .....	05
Charging Operation.....	05
Battery Charger Type .....	05
Notice for Charging Battery.....	05
How to Charge.....	06
Charging Prompt.....	08
How to Store the Battery.....	08
<b>INSTALLATION &amp; CONNECTION</b> .....	09
Installing / Removing the Li-ion Battery.....	09
Installing / Removing the Antenna.....	10
Installing / Removing the Belt Clip.....	10
Installing Optional Speaker / Microphone.....	11
<b>GETTING ACQUAINTED</b> .....	12
LCD Display.....	12
<b>BASIC OPERATIONS</b> .....	15
Turn the Radio On & OFF.....	15
Adjusting Volume .....	15
Switch between Main band and Sub band.....	16
Switch between Channel mode and VFO mode.....	16

## ◦ TABLE OF CONTENTS

Channel Adjusting.....	16
Frequency Adjusting.....	16
Frequency Input by Keypad.....	17
Channel Input by Keypad.....	17
Squelch Off Momentary / Squelch Off.....	18
Receiving.....	18
Transmitting.....	18
Emergency Alarm.....	19
Side Key [PF1] function instruction.....	19
Side key [PF2] function instruction.....	20
Edit channel.....	20
Delete channel.....	21
Programming scan.....	21
<b>SHORTCUT OPERATIONS.....</b>	<b>22</b>
Add/Cancel Optional signal decode function.....	22
CTCSS/DCS Scan.....	22
Offset Frequency Direction Setup.....	23
Frequency/Channel Scan.....	23
Channel Scan Skip.....	24
Frequency Reverse.....	24
TX Power selection.....	25
Stopwatch function.....	25
DTMF code Transmit and Enquiry.....	26
Keypad lock.....	26
Single-band switching.....	27
CTCSS/DCS encode and decode.....	27
<b>Function Menu Setup.....</b>	<b>28</b>

# o TABLE OF CONTENTS

CTCSS/DCS Encode Setup.....	28
CTCSS/DCS Decode Setup .....	29
CTCSS/DCS Encode/Decode Synchronous Setup .....	29
5TONE encode group selection .....	30
Optional signaling setup .....	31
Squelch mode setup.....	31
Frequency step size setup.....	32
Wide / Narrow Band Selection .....	33
Frequency Reverse.....	33
Talk Around ON/OFF .....	34
Offset Frequency setup.....	34
Editing Channel name.....	35
Busy Channel Lockout .....	35
TX OFF .....	36
Band Limit.....	36
Sub band display setup .....	37
Keypad Voice prompt setup.....	38
Time-Out-Timer (TOT) .....	38
Voice Operated Transmission (VOX) Setup.....	39
VOX Delay Setup.....	39
Automatic Power Off Time setup.....	40
DTMF Transmitting Time Setup.....	40
Squelch level setup .....	41
Scan Dwell Time Setup.....	41
Function Icon Stay Time Setup.....	42
LCD Backlight Setup.....	42
LCD Backlight Color Setup.....	43



## ◦ TABLE OF CONTENTS

Self ID inquiry .....	43
Tone Pulse Frequency Selection.....	44
Battery Save Setup .....	44
FM radio .....	45
FM Radio Functions.....	46
PF1 key Function Setup.....	46
<b>Senior Function Operations</b> .....	47
Display Mode Setup.....	47
Resume Factory Default.....	47
Cloning Cable.....	48
<b>Additional Functions for Version C and D</b> .....	50
Cross-Band Repeater( Version C and D).....	50
Sub-Radio Volume Setting( Version C and D) .....	50
Mute Setup (Version C and D).....	51
2TONE encode group selection (Version D).....	51
MSK encode group selection(Version D).....	52
Transmit MSK message (Version D) .....	52
Frequency Hopping (Version D).....	53
AM/FM/SW/LW Band (Version D).....	53
<b>Programming software starting (Takes Windows XP system for example)</b> .....	54
<b>TECHNICAL SPECIFICATION</b> .....	55
<b>TROUBLE SHOOTING GUIDE</b> .....	56
<b>ATTACHED CHART</b> .....	58
CTCSS Frequency Chart.....	58
1024 groups DCS frequency chart.....	59

## ○ UNPACKING

Please carefully unpack the transceiver. We recommend that you identify the items listed in the following table before discarding the packing material.

If any items are missing or have been damaged during shipment, please contact with dealers immediately.

### (((Supplied Accessories

Item	Number	Quantity
Antenna	QA09UV2	1
Li-ion Battery	QB-35L	1
Battery Charger	QBC-35L	1
AC Adaptor	QPS-01	1
Belt Clip	BC07	1
Instruction Manual		1

## ○ STANDARD ACCESSORIES/ADDITIONAL ACCESSORIES

### ☞ Standard Accessories



Antenna\*1  
QA09UV2  
145/435MHz



Li-ion Battery  
QB-35L



Battery Charger  
QBC-35L



AC Adaptor  
(12V/500mA)  
QPS-01



Belt Clip  
BC07



Instruction  
Manual

**\*1.Note:** For frequency band of antenna, please refer to label indicated in the bottom of the antenna.

### ☞ Additional Accessories



USB Programming  
Cable PC03



Programming  
Software  
QPS398UV



Earphone  
HS03



Car  
Charger  
CPL03

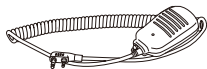

Handheld Microphone  
QHM22



Battery Pack for  
Car Charger CPS02



Telescopic antenna  
QA10UV

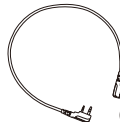

Cloning Cable  
CP04

## OPERATION MODE (AMATEUR TRANSCEIVER OR PROFESSIONAL TRANSCEIVER)

**AnyTone**  
*We only do best radio!*

The transceiver is a high performance amateur transceiver with dual band, dual standby, dual display and other kinds of functions. According to practical application, you can set the radio operates as Amateur Transceiver or Professional Transceiver. There are also 3 levels operation menu to set functions as per you need. It is easy and convenient.

### 1. Operation Mode:

**A. By programming software:** In PC software's "**General Setting**" menu to choose "**Display Mode**", channel mode works as Professional transceiver, other two modes as Amateur transceiver.

**B. By manual setup:** Please refer to "**Display Mode**" in Page 47.



(Pic 1)

**2. Amateur Transceiver Mode:** Except setting as CH mode, others considered as Amateur transceiver mode. Under this mode, press  key to switch between Channel mode and VFO.



(Pic 2)

**A. Frequency + Channel mode:** At this mode, When set display as "**FREQ**", it enters into Frequency+Channel mode, new setting of channel operation and shortcut operation can be temporarily used by user. Once the radio is turned off or switched to another channel, the temporary setting will be erased and back to initial settings.(As pic 1)

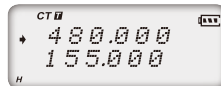

(Pic 3)

**B. Channel+Name Tag Mode:** When set display as "**NAME**", it enters into Channel+Name Tag Mode. At this mode, it will display corresponding channel name when the current channel is edited with name. Otherwise, it will display frequency+channel. Its operations are the same as frequency + channel mode. (As pic 2)



(Pic 4)

## ◦ WORKING MODE (AMATEUR TRANSCEIVER OR PROFESSIONAL TRANSCEIVER)

C. **VFO Mode(Frequency mode):** This mode shows only frequency on the display. Shortcut operation and Channel setting will be changed & stored as the latest value permanently. Once the radio is turned off or changed to new VFO frequency, the value is remained until next change.(As pic 3)

3. **Professional Transceiver Mode:** When set display mode as "CH", it enters into Professional Transceiver mode. At this mode, except scan, DTMF encode or editing, and keypad lock, other functions should be set by PC software. (As pic 4)

**NOTE: If transceiver programmed transceiver as professional mode, you can't return to amateur transceiver mode by manually from Background operations setting.**

4. Under every mode, background operations can be changed and saved.

### ((( Charging Operation

The battery is not charged at the factory, please charge it before use. Charge the battery for the first time after purchase or extended storage (more than 2 months) may not bring the battery to its normal operating capacity. After repeating fully charge/discharge cycle for two or three times, the operating capacity will reach the best performance. The battery life is over when its operating time decreases even though it is fully and correctly charged. Replace the battery.

### ((( Battery Charger Type

Please use our company's designated charger, other models may cause explosion and injure people. After installing the battery, if the radio red light twinkles and remind changing battery, please charge the battery.

### ((( Notice for Charging Battery

- ▲ Do not shortcircuit our company designated charger. Never attempt to remove the casing from the battery, we show no responsibility on the faulty caused by modifying freely without permission of our factory.
- ▲ The ambient temperature should be between 5°C and 40°C in charging. Charging outside this range may not fully charge the battery.
- ▲ Always switch off the transceiver equipped with a battery before charging. Otherwise, it will interfere with correct charging.
- ▲ To avoid interfering the charging procedure, please do not cut off the power or take out the battery during charging.

## ○ BATTERY INFORMATION

- ▲ Do not recharge the battery if it is already fully charged. This may shorten the life of the battery or damage the battery.
- ▲ Do not charge the battery or transceiver if it is damp. Dry it before charging to avoid danger.

### **WARNING:**

**When keys or ornamental chains and other electric metals contact with the battery terminals, the battery may cause damage or hurt bodies. If the battery terminal short circuit, it will generate a lot of heat, please be careful when you bring or use the battery, please put battery or radio into insulated container. Do not put it into metal container.**

## ((( How to Charge



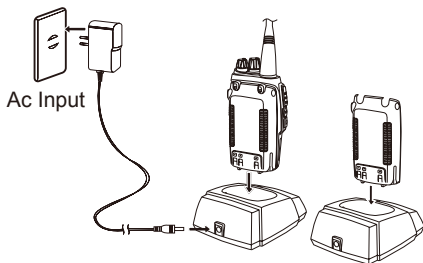

- 1.Plug the AC adaptor into the AC outlet, then plug the cable of AC adaptor into the DC jack, the indicator lights orange for 1s and turns into GREEN --- waits to charge.
- 2.Slide the battery or transceiver with battery into the charger; make sure the battery terminals are in contact with the charging terminals well. LED turns into twinkling RED --- pre-charging begins.
- 3.Pre-charging for about 5 minutes, LED twinkles stop then charging begins.
- 4.It takes about 5.5 hours to fully charge the battery, when LED turns into GREEN — full charged



## ○ BATTERY INFORMATION

**NOTE:** When charging a power-on transceiver equipped with battery, the LED will not turn into green to show the full charge status. Only when turn off the transceiver, the LED can indicate normally. Because when the transceiver is power on, it would consumes energy, the charger cannot detect when battery has been fully charged, the charger will charge battery in voltage consumption and fail to indicate correctly.

### 5.Charging Process:

Status	LED
Standby (self-examine orange lights 1second when power on)	 Green light
Pre-charging (pre-charging stage)	 Red light twinkles for about 5 minutes
Charging (charge in constant current)	 RED light lightens for about 5.5 hours
Full charged (charge in constant voltage)	 Green light

### 6.LED Indicator:

STATUS	self-examine when power on	(No battery)	Pre-charging	Charge normally	Full Charged	Trouble
LED	Orange (for 1 second)	Green	Red light twinkles for 5 minutes	Red	Green	Red twinkles for a long time

**NOTE:** Trouble means battery heating, battery short-circuit or charger short-circuit.



## ○ BATTERY INFORMATION

### ((( Charging Prompt

1. Self-examination: When charging, ORANGE light twinkles for 1 second and goes out. That means the charger has passed its self-examination and it can charge the battery normally. If the light remains orange or the red light twinkles, which means the charger can not pass its self-examination or charge the battery.
2. Trickle pre-charging: When the battery has been inserted into the charger and red light twinkles, which means the remnant voltage is low, the charger trickle charge the battery (pre-charging status ), until the battery reaches a certain electric quantity, the charger automatically turns into normal charging. And if the red light stop twinkling, which means the remnant voltage meets a certain electric quantity, the charger will charge the battery normally.

**NOTE:**The time for Trickle pre-charging is not exceed 30m. After 30m, the red indicator is still twinkling, it means it is unable to charge battery. Please kindly check battery and charger.

### ((( How to Store the Battery

1. If the battery needs to be stored for a long period, the battery should be removed from the radio. It's state of charge should be 50-100% charged.
2. It should be kept in low temperature, dry environment.
3. To keep away from hot places and direct sunlight.

#### **WARNING**

- ▲ Do not short circuit battery terminals.
- ▲ Never attempt to remove the casing from the battery pack.
- ▲ Never assemble the battery in dangerous surroundings, spark may cause explosion.
- ▲ Do not put the battery in hot environment or throw it into fire, it may also cause explosion.

### ((( Installing / Removing the Li-ion Battery

#### ■ Installing Battery

1. Match the two grooves of the battery pack with the corresponding guides on the back of transceiver, then push it.
2. Press the bottom of battery, the lock latch on bottom of the transceiver will release. After hearing a "click" sounds, the battery has been locked.

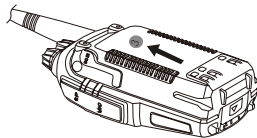
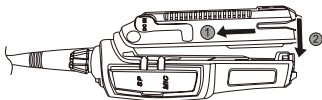

#### ■ Removing the battery

Slide the battery lock according to "▼" indicate direction, the battery can be take off.

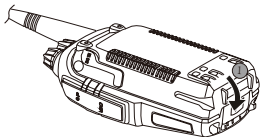

## ◦ INSTALLATION & CONNECTION

### ((( Installing / Removing the Antenna

#### ■ **Installing the Antenna:**

Screw the antenna into the connector on the top of the transceiver by holding the antenna base and turning it clockwise until secure.

#### ■ **Removing the Antenna:**

Turn the antenna anticlockwise to remove it.

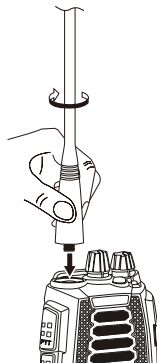

### ((( Installing / Removing the Belt Clip

#### ■ **Installing the Belt Clip:**

Place the belt clip to the corresponding grooves on the back of the transceiver, and then Clockwise screw it.

#### ■ **Removing the Belt Clip:**

Anticlockwise turn screws to remove the belt clip.

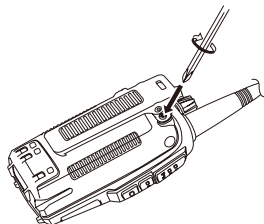

## ◦ INSTALLATION & CONNECTION

**AnyTone**  
*We only do best radio!*

### ((( Installing Optional Speaker / Microphone

Uncover the jack cover and then insert the microphone plug into microphone jack.

If the microphone is not used anymore, please cover the Speaker/Microphone jack.

#### **NOTE:**

- 1. To keep the transceiver water resistant, you must cover the Speaker/Microphone jacks with the supplied cover.**
- 2. The transceiver is not completely water resistant while using the Speaker/Microphone.**

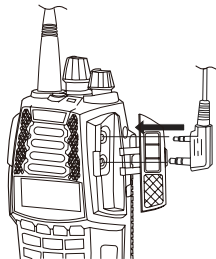

## ◦ GETTING ACQUAINTED

### ((( LCD Display

On LCD display screen, you will see various icons which stand for the selected functions and sometimes you may forget the meaning of them. Here you will find the following table extremely useful.

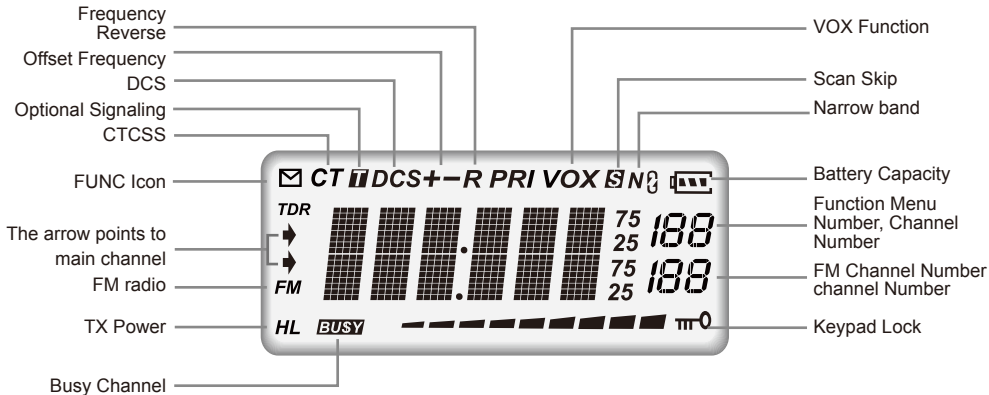

#### NOTE:

Battery capacity indicator(full)

Battery capacity remnant

No power,replace battery pack or charge battery

Real time display receiving signal strength/Power Indicator

## ◦ GETTING ACQUAINTED

**AnyTone**  
*We only do best radio!*

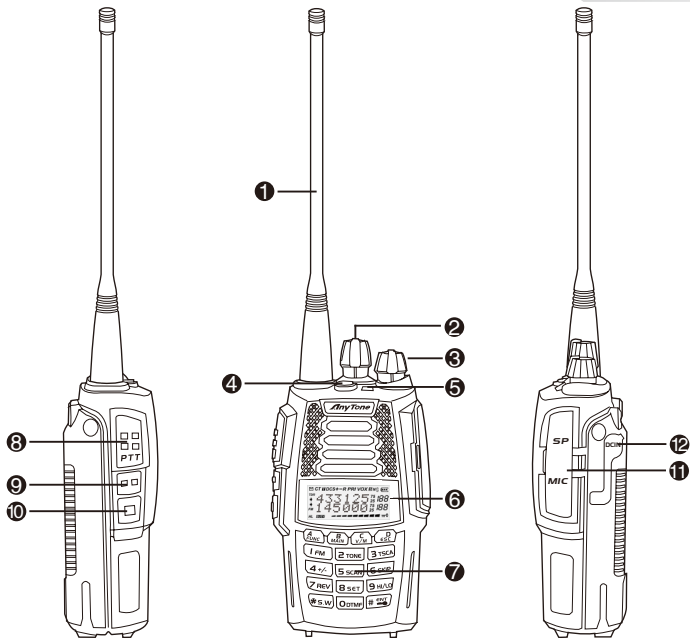

## ◦ GETTING ACQUAINTED

- ❶ Antenna
- ❷ Channel switch
- ❸ POWER/VOLUME switch  
Rotate it clockwise to turn on transceiver, rotate it anticlockwise until heard "click" to turn off the transceiver.  
When transceiver is power on, rotate it clockwise to increase volume, anticlockwise to reduce volume.
- ❹ Emergency Alarm  
Under standby state, press and hold Emergency alarm key for 3 seconds to start alarm function, power off transceiver to exit alarm.
- ❺ Indicator
- ❻ LCD display  
Displays current frequency/channel and operations.
- ❼ Keypad  
Enters desired frequency/channel or operations by keypad.
- ❽ PTT key  
Press PTT key to talk, release this key to receive.
- ❾ PF1 key
- ❿ PF2 key
- ⓫ Speaker/Microphone jack, programming software jack
- ⓬ Car charger port  
When using this port for charging, must pair with car charger CPL03, otherwise battery will be broken.
- ⓭ Single-band Switching
- ⓮ Sub-Radio Volume Setting (Version C) / Transmit MSK message (Version D)

## ◦ BASIC OPERATIONS

**AnyTone**  
*We only do best radio!*

### ⌂ Turn the Radio On & OFF



Under power-off state, please turn **[POWER]** / **[VOLUME]** clockwise to turn on the transceiver.



Under power-on state, please turn **[POWER]** / **[VOLUME]** anticlockwise to turn off the transceiver.

### ⌂ Adjusting Volume



Under power-on state, turn **[POWER]** / **[VOLUME]** to adjust volume. Clockwise-up, anticlockwise -down.  
When adjusting the volume, user can press the key programmed as Squelch Off to monitor current volume firstly.

#### **NOTE:**

**Press the side key programmed as Squelch Off Momentary to monitor the background noise. Turn [POWER]/ [VOLUME] to control the volume. The volume you need can be adjusted more correctly when communicating with the other party.**



## ◦ BASIC OPERATIONS

### ((( Switch between Main band and Sub band

Under standby state, press  key to switch channel between Main band and Sub band. Arrow directs the current operational channel.

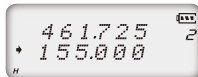

### ((( Switch between Channel mode and VFO mode

Under standby state, press  key to set main band as Channel mode or frequency mode(VFO).

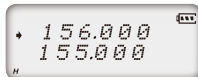

### ((( Channel Adjusting

When transceiver in Channel mode or FM radio channel mode, rotate channel switch to adjust channel. Rotate channel switch clockwise to enter the downward channel, anticlockwise to enter the upward channel.

**NOTE: In transceiver mode, arrow directs the main band channel.**

**If there is a null channel between two channels, transceiver will skip null channel, enter into next channel directly.**

### ((( Frequency Adjusting

When transceiver in VFO mode or FM radio frequency mode, rotate channel switch to adjust frequency. Rotate channel switch clockwise to increase frequency, anticlockwise to decrease frequency. Every rotate can add or reduce one stepping value.

**NOTE: Channel step:2.5K, 5K, 6.25K, 10K, 12.5K, 20K, 25K, 30K and 50KHz in total 9 for optional. FM radio step frequency is 50K.**

### ((( Frequency Input by Keypad

Under frequency mode or FM radio frequency mode, you can directly enter frequency through keypad.

1. When your transceiver is under Channel mode, press  key to switch into VFO.

**NOTE: When the transceiver is under Channel mode, it shows current channel number on the right of main frequency.**

2. Enter the desired frequency by keypad.

**NOTE: The frequency input of main channel or FM radio is relevant to the stepping and transceiver frequency range. If frequency setup is beyond range or not matching with step size, the input is unavailable. Under the FM radio mode, the frequency step size input by numeric keys is 100k.**

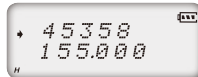

### ((( Channel Input by Keypad

Under channel mode of transceiver or FM radio, you can switch to desired channel by entering three numbers (001-199). If the entered channel is not in edited channel range, the transceiver will emit beep to prompt wrong input and return to current channel. For example, entering 001 is channel 1, 030 is channel 30, 125 is channel 125.



## ◦ BASIC OPERATIONS

### ((( Squelch Off Momentary / Squelch Off

Side key [PF2] can be setup for Squelch off Momentary or Squelch off function by programming software.

- 1.Squelch off: Press [PF2] key, squelch circuit is not mute, back-ground noise can be heard. Press [PF2] key again, squelch circuit is mute.
- 2.Squelch off Momentary: Press and hold [PF2] key, squelch circuit is not mute, back-ground noise can be heard. Release [PF2] key, squelch circuit is mute.

**NOTE: The above functions are only available after [PF2] key setup in programming software.**

### ((( Receiving

When your transceiver is called by other party, the green LED light will be on and the arrow icon will flash, you can hear the calling.

**NOTE: You may not receive the calling when your transceiver is set at high squelch level. If current channel is programmed with decode signal, only the same signaling call can be heard.**

### ((( Transmitting

According to [PF2] key setup in programming software, hold [PF2] key to monitor the channel to ensure it is not busy, press PTT key and talk to speaker.

Please keep the distance between mouse and speaker to be 2.5-5CM, speak in normal tone to get the best acoustic fidelity.

**NOTE:** When press and hold PTT key, transceiver is transmitting if the red LED light is on, release PTT key to receive calls.

### ⓘ Emergency Alarm

Under standby state, press and hold alarm key until LCD displays "**ALARM**", Emergency alarm function is started. This transceiver has 4 Alarm modes for optional, can be setup in programming software. Power off transceiver to exit Alarm.

### ⓘ Side Key [PF1] function instruction

[PF1] key can be setup in Function Menu 45 for below functions:

1. **VOLT:** Battery capacity inquiry: Under standby, press [PF1] key, LCD displays current battery capacity, press this key again to exit.
2. **CALL:** Transmit the prestored DTMF/5TONE Encode signal in channel.
3. **ALARM:** Long pressing [PF1] key, LCD display "**ALARM**", transceiver will enable the preset alarm function.
4. **SUBPTT:** Press [PF1] key, transceiver will transmit at sub-band frequency.
5. **FHSS:** Press [PF1] key, transceiver will communicate in preset hopping frequency range.(FHSS function is only available for Version D)
6. **Transmit tone pulse frequency:** Press and hold PTT key, then press [PF1] key to transmit selected tone pulse frequency.

**NOTE:** The tone pulse frequency can be set to 1750Hz, 1450Hz, 1000Hz or 2100Hz in programming software. Please refer to function menu No.29 Tone plus frequency setup (Page 44).

## ◦ BASIC OPERATIONS





### ((( Side key [PF2] function instruction

1. Squelch off: Press [PF2] key, squelch circuit is not mute, back-ground noise can be heard. Press [PF2] key again, squelch circuit is mute.
2. Squelch off Momentary: Press and hold [PF2] key, squelch circuit is not mute, back-ground noise can be heard. Release [PF2] key, squelch circuit is mute.
3. Transmit DTMF/5TONE signaling: Press and hold PTT key, then press [PF2] key to transmit selected DTMF/5TONE signaling.





**NOTE: The optional signaling of current channel is DTMF or no optional signaling, the operation will transmit DTMF signaling.**

4. Press and hold [PF2] key to turn on transceiver, until transceiver emits "DU" beep, transceiver enter into general functions setup.

### ((( Edit channel

1. Under frequency mode (VFO), enter desired frequency and settings, press  key, the top left corner of LCD displays "✉" icon, press  key to switch into channel mode, channel number flashes.
2. Rotate channel switch to select desired editing channel number.
3. Press  key, the top left corner of LCD displays "✉" icon, press and hold  key until transceiver emits "DUDU" beep, channel is stored successfully.





### (((Delete channel

1. Under standby state, press  key, the top left corner of LCD displays "✉" icon, press  key to switch into channel mode, channel number flashes.
2. Rotate channel switch to select desired deleting channel number.
3. Press  key, the top left corner of LCD displays "✉" icon, press and hold  key until transceiver emits "DUDU" beep and clear up frequency information of current channel, deletion is successful.

**NOTE: This process can be applied for deleting FM radio channels.**

### (((Programming scan



Setup the frequency of L1 channel, U1 channel, L2 channel and U2 channel will realize VFO frequency scanning border limited. L1 & L2 is starting frequency, U1 & U2 is end frequency. When VFO frequency between L1~ U1 or L2 ~ U2, transceiver will scan frequencies between L1 ~ U1 or L2 ~ U2. When VFO frequency is lower than L1 or L2, transceiver will scan frequencies higher than L1 or L2. When VFO frequency is higher than U1 or U2, transceiver will scan frequencies higher than U1 or U2.

1. In VFO mode, enter desired frequency and relative setup, press  key, the top left corner of LCD displays "✉" icon, then press  key switch into channel mode, channel number flashes.
2. Rotate channel switch to choose desired channel number.
3. Press  key, the top left corner of LCD displays "✉" icon, then press  key until transceiver emits "DUDU" beep, channels are saved successfully.

**NOTE: To make this setup, L1 and U1 must in same frequency band. L2 and U2 must in same frequency band.**

## ○ SHORTCUT OPERATIONS



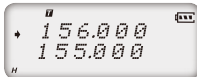

### ((( Add/Cancel Optional signal decode function

Under standby state, press  key, the top left corner of LCD displays "✉" icon, press  key, LCD displays "T" icon, it means current channel add DTMF signal decode function. Repeat above operation, LCD still displays "T" icon, it means current channel add 5TONE signal decode function. Repeat above operation, "T" icon disappears, optional signal decode function is cancelled.



**NOTE:** When this function is on, user must setup 06th menu to be TONE option, then DTMF/5TONE can be used.

### ((( CTCSS/DCS Scan

Press  key, the top left corner of LCD displays "✉" icon, press  key to enter into CTCSS/DCS scan. Under this state, rotate channel switch to change scan direction. When scan the matching CTCSS/DCS signaling, it will stay 5seconds and then go on scanning. Press any other keys except , ,  key to exit.

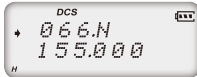

**NOTE:** This function is invalid when transceiver works in professional mode or the arrow directed channel no setting CTCSS/DCS signaling.

In current channel, if signaling set as CTCSS, it will scan CTCSS, if sets as DCS, will scan DCS.

### Offset Frequency Direction Setup

Under standby state, press **[A FUNC]** key, the top left corner of LCD displays "✉" icon, press **[4 +/-]** key to choose offset frequency direction. There are 3 options, Positive offset, Minus offset, shut off offset.

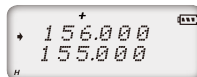

1. (+) Positive offset: Indicates TX frequency is higher than RX frequency. When enable reverse function, the RX frequency is higher than TX frequency.
2. (-) Minus offset: Indicates TX frequency is lower than RX frequency. When enable reverse function, the RX frequency is lower than TX frequency.
3. None: Indicates shut offset off.

Under frequency mode (VFO) or channel mode, press **[A FUNC]** key then press **[4 +/-]** key to choose positive offset direction (+), minus offset direction (-), shut offset off one by one (Please refer to offset frequency setup).

**NOTE: This function is unavailable in professional transceiver mode.**

### Frequency/Channel Scan

Under corresponding mode, press **[A FUNC]** key, the top left corner of LCD displays "✉" icon, then press **[5 SCAN]** key to start frequency scan or channel scan.

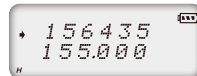

1. Frequency Scan

Under VFO mode, frequency scan is available. This function is used for monitoring signal of various communication frequency by transceiver 'step' setup, press numeric key or **[D ESC]** key to exit.

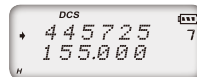



## ◦ SHORTCUT OPERATIONS



### 2. Channel Scan

Under channel mode, this function is used for monitoring signal of each channel in this mode. Press numeric key or  key to exit.

#### NOTE:

- ▼ Frequency scan is of all bands scan, it scans upwards as your STEPPING setting.
- ▼ In channel scan, the skipped channel is not in the line of scanning. Scan upwards as per channel no. (please refer to channel scan skip).
- ▼ Frequency/channel scan can change scan direction by rotating channel switch, when find a matching carrier wave and signaling, the transceiver will stay 5 seconds then go on scanning. (Please refer to scan setup)



### ((( Channel Scan Skip

Under channel mode, press  key, the top left corner of LCD displays "✉" icon, then press  key to set current arrow directed channel as Channel scan skip. Repeat above operation to cancel channel scan skip.

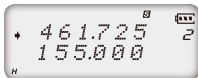
1. LCD displayed "S" means the current channel will not be scanned.
2. "S" icon disappeared means the current channel will be scanned.



### ((( Frequency Reverse

Under standby state, press  key, the top left corner of LCD displays "✉" icon, then press  key to set arrow directed channel as frequency reverse, repeat above operation to turn off frequency reverse.

## ○ SHORTCUT OPERATIONS

1. When LCD displays "R" icon, it means current arrow directed channel open the frequency reverse function, the TX frequency and RX frequency is interchanged, if CTCSS/DCS signaling is set, it will also interchange.
2. When "R" icon disappears, it means reverse function is close.

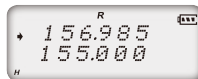

### Ⓜ TX Power selection

Under standby state, press key, the top left corner of LCD displays "✉" icon, then press key to choose High/Low power for current arrow directed channel.

1. When LCD displays "L" icon, it means low power is chose.
2. When LCD displays "H" icon, it means high power is chose.

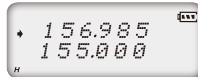
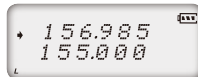

### Ⓜ Stopwatch function



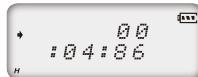

1. Under standby state, press key, the top left corner of LCD displays "✉" icon, then press to enter into stopwatch function.
2. Press key to start timing. Under this state, press key to pause timing. When timing is pause, press key to continue timing.
3. Press [PF1], [PF2] or key to exit stop watch function.



**NOTE:** During timing, press key to stop timing and displays current data, press this key again to clear timer.

## ◦ SHORTCUT OPERATIONS



### Ⓜ DTMF code Transmit and Enquiry

1. Press  key, the top left corner of LCD displays "✉" icon, then press  key, LCD displays DTMF data and group number (total 16groups) of current group.
2. Rotate channel switch to choose desired group and DTMF data, press PTT key to transmit selected DTMF signaling. If current group not edit DTMF data, LCD displays "EMPTY".
3. When current group displays "EMPTY", press  key, the top left corner of LCD displays "✉" icon, press and hold  key until transceiver emits "DU" beep, transceiver enters into DTMF edit state, LCD displays "\_\_\_\_\_", now you can enter desired DTMF data by keypad.
4. When finished editing, press side key [PF2] to save DTMF signaling.



### Ⓜ Keypad lock

In order to prevent wrong operation, user can make use of keypad lock function.

Under standby state, press  key, the top left corner of LCD displays "✉" icon, then press and hold  key until transceiver emits "DU" beep, LCD displays "☞" icon, keypad is locked. Repeat above operation, "☞" icon disappears, key lock function is cancelled.

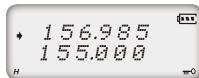

### ((( Single-band Switching

To reduce the interference from the sub-channel when the main channel be used. You can use single-band switching function, turn off the sub-channel bands quickly.

1. In standby mode, press the **\*S.W** button, the radio will display the PC channel, and turn off the processor channel.
2. Click the **\*S.W** button again, the radio will display the processor channel, and turn off the PC channel.
3. Press the **\*S.W** button again to return to dual-band show.



### ((( CTCSS/DCS encode and decode

1. Press **A FUNC** key then press [PF2] to enter into setup.
2. Press [PF2] key to choose CTCSS, DCS or OFF, when choose DCS, press **\*S.W** key to select positive or negative code.
3. Rotate Channel selector to choose desired CTCSS/DCS encode and decode.
4. Press **D ESC** key or **# ENT** key to confirm and exit.

## ○ FUNCTION MENU SETUP

Menu 1-14 of this transceiver are channel operations. Channel operations temporarily changed the functions of current channel. When power off or channel has been changed, the relevant setup will be erased. Only under VFO mode, the channel operations will be saved until next change. Menu 15-32 is background operation, it is valid for all channels, the relevant setup will be saved until next change.

The operating methods are as follows:

1. Press **[A FUNC]** key, the top left corner of LCD displays "✉" icon, then press **[B SET]** key to enter function menu.
2. Press **[B MAIN]** / **[C V/M]** key to choose desired function.
3. Rotate channel switch to choose desired setting.
4. Press **[D ESC]** key or **[# ENT]** key to confirm and exit.

### ((( CTCSS/DCS Encode Setup

1. Press **[A FUNC]** key, the top left corner of LCD displays "✉" icon, then press **[B SET]** key to enter into function menu.
2. Press **[B MAIN]** / **[C V/M]** key to choose NO. 01 function item, it shows "T-CDC" on LCD.
3. Press **[I FM]** key to choose CTCSS, DCS or OFF, when DCS signaling is selected, press **[\*SW]** key to choose DCS positive or inverse code.
4. Rotate channel switch to choose desired CTCSS/DCS code.

**CTCSS:** 62.5Hz-254.1Hz, 51 groups in total, and 1 group user-defined code.

**DCS:** 000N-777I, 232 groups in total. "N" stands for positive code, "I" stands for inverse code.

5. Press **[D ESC]** or **[# ENT]** key to confirm and exit.

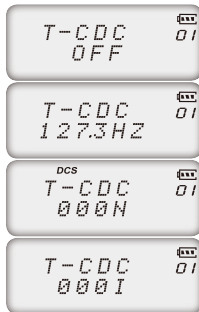

**Note: User-defined CTCSS encode must be setup by programming software.**

### CTCSS/DCS Decode Setup

If this function is enabled, you can ignore (can not hear) other unrelated call at the same frequency.

1. Press **[A FUNC]** key, the top left corner of LCD displays "✉" icon, then press **[B SET]** key to enter into function menu.
2. Press **[B MAIN]** / **[C V/M]** key to choose NO. 02 function item, it shows "R-CDC" on LCD.
3. Press **[I FM]** key to choose CTCSS, DCS or OFF, when DCS signaling is selected, press **[\*SW]** key to choose DCS positive or inverse code.
4. Rotate channel switch to choose desired CTCSS/DCS code.  
**CTCSS:** 62.5Hz~254.1Hz, 51 groups in total, and 1 group user-defined code. **DCS:** 000N-777I, 232 groups in total. "N" stands for positive code, "I" stands for inverse code.
5. Press **[D ESC]** or **[# CHG]** key to confirm and exit.



**Note: User-defined CTCSS decode must be setup by programming software.**

### CTCSS/DCS Encode/Decode Synchronous Setup

This function is for adjusting CTCSS/DCS encode/decode synchronous.

1. Press **[A FUNC]** key, the top left corner of LCD displays "✉" icon, then press **[B SET]** key to enter into function menu.
2. Press **[B MAIN]** / **[C V/M]** key to choose NO. 03 function item, it shows "RT-CDC" on LCD.



## ○ FUNCTION MENU SETUP

3. Press **[FM]** key to choose CTCSS,DCS or OFF, when DCS signaling is selected, press **[\*S.W]** key to choose DCS positive or inverse code.

4. Rotate channel switch to choose desired CTCSS/DCS encode/decode.

**CTCSS:** 62.5Hz~254.1Hz, 51 groups in total, and 1 group user-defined code.

**DCS:** 000N-777I, 232 groups in total. "N" stands for positive code, "I" stands for inverse code.

5. Press **[D ESC]** or **[# ENT]** key to confirm and exit.



### ((( 5TONE encode group selection

1. Press **[A FUNC]** key, the top left corner of LCD displays "☑" icon, then press **[B SET]** key to enter into function menu.

2. Press **[B MAIN]** / **[C V/M]** key to choose NO.04 function item, it shows "5T-ENC" on LCD.

3. Rotate channel switch to choose desired 5TONE encode group.

CALL00~CALL99, 100 groups in total for optional.

4. Press [PTT] key to transmit selected 5TONE encode, press **[D ESC]** key or **[# ENT]** key to confirm and exit.



**5TONE encode must be programmed by software, only the groups with editing 5TONE can be selected. When 5TONE encode is editing with name, transceiver will display name, otherwise will display " CALL XX ".**

### ((( Optional signaling setup

DTMF and 5TONE functions are similar to CTCSS/DCS, it has special call functions, such as ANI, PTT ID, All call, Alarm, remotely kill, remotely stun and remotely waken, etc..

1. Press **[A FUNC]** key, the top left corner of LCD displays "✉" icon, then press **[B SET]** key to enter into function menu.
2. Press **[B MAIN]** / **[C V/M]** key to choose NO. 05 function item, it shows "TONDEC" on LCD.
3. Rotate channel switch to choose desired optional signaling.

**DTMF:** Current optional signaling is DTMF.

**5TONE:** Current optional signaling is 5TONE.

**OFF:** Close optional signaling.

4. Press **[D ESC]** key or **[# ENT]** key to confirm and exit.



**Default configuration is 5TONE, 2TONE can be customized according to different market requirements.**

### ((( Squelch mode setup

This function is used for setting squelch mode to prevent receiving unrelated singals.

1. Press **[A FUNC]** key, the top left corner of LCD displays "✉" icon, then press **[B SET]** key enter into function menu.
2. Press **[B MAIN]** / **[C V/M]** key to choose NO. 06 function item, it shows "SIGNAL" on LCD.
3. Rotate channel switch to choose desired squelch mode.





## ○ FUNCTION MENU SETUP

**SQ:** When current channel receives matching RF signals, transceiver can hear the talking from the other party.

**CT/DCS:** When current channel receives matching RF signals and matching CTCSS/DCS signaling, transceiver can hear the talking from the other party.

**STONE:** When current channel receives matching RF signals and matching optional signaling, transceiver can hear the talking from the other party.



**CT&TO:** When current channel receives matching RF signals + matching optional signaling + matching CTCSS/DCS signaling, transceiver can hear the talking from the other party.

**CT/TO:** When current channel receives matching RF signals, or matching optional signaling, or matching CTCSS/DCS signaling, transceiver can hear the talking from the other party.



4. Press  key or  key to confirm and exit.

## ((( Frequency step size setup

1. Press  key, the top left corner of LCD displays "☑" icon, then press  key enter into function menu.

2. Press  /  key to choose NO. 07 function item, it shows "STEP" on LCD.

3. Rotate channel switch to choose desired step size.

**Stepping:** 2.5K, 5K, 6.25K, 10K, 12.5K, 20K, 25K, 30K, 50K, 9 options in total.

4. Press  key or  key to confirm and exit.



**NOTE: This function item will hide automatically when main band and sub main band are under channel mode.**

### Wide / Narrow Band Selection

According to the national conditions of various countries, it can be set for communication by wide band or narrow band.

1. Press **A** FUNC key, the top left corner of LCD displays "☑" icon, then press **B** SET key enter into function menu.
2. Press **B** MAIN / **C** V/M key to choose NO. 08 function item, it shows "W/N" on LCD.
3. Rotate channel switch to choose desired setup.  
**25K**: Wide band, **12.5K**: Narrow band
4. Press **D** ESC key or **#** SINT key to confirm and exit.



### Frequency Reverse

1. Press **A** FUNC key, the top left corner of LCD displays "☑" icon, then press **B** SET key enter into function menu.
2. Press **B** MAIN / **C** V/M key to choose NO. 09 function item, it shows "REV" on LCD.
3. Rotate channel switch to choose desired setup.  
**ON**: Turn on Frequency reverse function, TX and RX frequency of current channel will be interchanged. If CTCSS/DCS signaling is set, it also will be interchanged.  
**OFF**: Close Frequency reverse function.







## ○ FUNCTION MENU SETUP

4. Press  key or  key to confirm and exit.

### ((( Talk Around ON/OFF

When this function is on, transceiver will cut communication with repeater.

1. Press  key, the top left corner of LCD displays "☑" icon, then press  key enter into function menu.
2. Press  /  key to choose NO. 10 function item, it shows "TALKAR" on LCD.
3. Rotate channel switch to choose desired setup.

**TX-RX:** Turn on Talk Around function, current channel will transmit at RX frequency, if CTCSS/DCS signaling is set, it will interchange decoding CTCSS/DCS as encoding.





**OFF:** Close Talk Around function.

4. Press  key or  key to confirm and exit.



### ((( Offset Frequency setup

This function works through repeater. When repeater receives signals at one frequency, it transmits at the other frequency. The offset between these two frequencies is called offset frequency.

1. Press  key, the top left corner of LCD displays "☑" icon, then press  key enter into function menu.
2. Press  /  key to choose NO. 11 function item, it shows "OFFSET" on LCD.



## ○ FUNCTION MENU SETUP



3. Rotate channel switch to choose desired offset frequency.



Frequency range is 00-70MHz.

4. Press  key or  key to confirm and exit.

### ((( Editing Channel name

1. Press  key, the top left corner of LCD displays "✉" icon, then press  key enter into function menu.

2. Press  /  key to choose NO. 12 function item, it shows "-" on LCD.

3. Rotate channel switch to choose desired character, press  key to confirm current character and move shift to next character. Press  key back to the previous character.

4. Press  key or  key to confirm and exit.



### ((( Busy Channel Lockout

BCLO function is used for prohibit transmitting on busy channel, it can prevent disturbing other transceivers operating in same frequency. If you press PTT, the radio will beep as warning and get back to receiving state.

1. Press  key, the top left corner of LCD displays "✉" icon, then press  key enter into function menu.

2. Press  /  key to choose NO. 13 function item, it shows "RPLOCK" on LCD.

3. Rotate channel switch to choose desired setup.



## ○ FUNCTION MENU SETUP

**BUSY:** Carrier wave lock, transmitting is prohibited when received matching carrier wave.





**REPEAT:** Signaling lock, transmitting is prohibited when received matching carrier but with unmatching CTCSS/DCS.

**OFF:** Close BCLO function.

4. Press  key or  key to confirm and exit.

### ((( TX OFF

When this function is on, [PTT] key is unavailable. Current channel of transceiver only works under receiving mode.

1. Press  key, the top left corner of LCD displays "☒" icon, then press  key enter into function menu.
2. Press  /  key to choose NO. 14 function item, it shows "TX" on LCD.
3. Rotate channel switch to choose desired setup.

**ON:** TX OFF is enabled.

**OFF:** TX OFF is disabled.

4. Press  key or  key to confirm and exit.

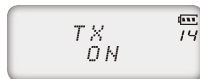

### ((( Band Limit

When this function is on, inputting frequency or Scanning frequency under VFO is limited in current VFO frequency band.

## ○ FUNCTION MENU SETUP

1. Press **A** FUNC key, the top left corner of LCD displays "☑" icon, then press **B** SET key enter into function menu.
2. Press **B** MAIN / **C** V/M key to choose NO. 15 function item, it shows "**BAND**" on LCD.
3. Rotate channel switch to choose desired setup.  
**ON**: Band limit is enabled.  
**OFF**: Band limit is disabled.
4. Press **D** ESC key or **#** ENT key to confirm and exit.









## ((( Sub Band Display Setup

1. Press **A** FUNC key, the top left corner of LCD displays "☑" icon, then press **B** SET key enter into function menu.
2. Press **B** MAIN / **C** V/M key to choose NO. 16 function item, it shows "**DSPSUB**" on LCD.
3. Rotate channel switch to choose desired setup.  
**FREQ**: Display sub band frequency or channel.  
**VOLT**: Display current battery voltage.  
**OFF**: Sub band display is disabled.
4. Press **D** ESC key or **#** ENT key to confirm and exit.



## ○ FUNCTION MENU SETUP







### Ⓜ Keypad Voice Prompt Setup

1. Press  key, the top left corner of LCD displays "✉" icon, then press  key enter into function menu.
2. Press  /  key to choose NO. 17 function item, it shows "BEEP" on LCD.
3. Rotate channel switch to choose desired setup.  
**ON:** Keypad Voice Prompt is enabled.  
**OFF:** Keypad Voice Prompt is disabled.
4. Press  key or  key to confirm and exit.



### Ⓜ Time-Out-Timer (TOT)

The purpose of Time-out-Timer is to restrict transceiver for continuous long-term transmission. When the continuous transmission time is beyond the preset time, transceiver is forced to stop transmitting and make a beep sound.

1. Press  key, the top left corner of LCD displays "✉" icon, then press  key enter into function menu.
2. Press  /  key to choose NO. 18 function item, it shows "TOT" on LCD.
3. Rotate channel switch to choose desired setup.  
1~27 minutes, total 27minutes of TOT for optional, each interval is 1minute.
4. Press  key or  key to confirm and exit.



### ④ Voice Operated Transmission (VOX) Setup

When this function is on, the transmitting can be started by voice, no need to press [PTT] key.

- Press **A FUNC** key, the top left corner of LCD displays "✉" icon, then press **B SET** key enter into function menu.
- Press **B MAIN** / **C V/M** key to choose NO. 19 function item, it shows "VOX" on LCD.
- Rotate channel switch to choose desired setup.  
**1~10** : Total 10 VOX levels for optional.  
**OFF**: VOX function is disabled.
- Press **D ESC** key or **# ENT** key to confirm and exit.



### ④ VOX Delay Setup

If transceiver returns to receive mode instantly after VOX calling, it may cause calling voice missing. To avoid this problem, user can set a suitable delay time.

- Press **A FUNC** key, the top left corner of LCD displays "✉" icon, then press **B SET** key enter into function menu.
- Press **B MAIN** / **C V/M** key to choose NO. 20 function item, it shows "VDELAY" on LCD.
- Rotate channel switch to choose desired setup.  
**0.5S-3S**: Total 27 levels for optional, each interval is 0.1S
- Press **D ESC** key or **# ENT** key to confirm and exit.





## ○ FUNCTION MENU SETUP

### Ⓢ Automatic Power Off Time setup

When this function is on, transceiver will automatic power off when reach the preset time.

1. Press **A FUNC** key, the top left corner of LCD displays "☒" icon, then press **B SET** key enter into function menu.
2. Press **B MAIN** / **C V/M** key to choose NO. 21 function item, it shows "APO" on LCD.
3. Rotate channel switch to choose desired setup.  
**30minutes ~ 2hours**: Total 3 levels for optional.  
**OFF**: Automatic Power Off Time is disabled.
4. Press **D ESC** key or **# ENT** key to confirm and exit.



### Ⓢ DTMF Transmitting Time Setup

1. Press **A FUNC** key, the top left corner of LCD displays "☒" icon, then press **B SET** key enter into function menu.
2. Press **B MAIN** / **C V/M** key to choose NO. 22 function item, it shows "DTMF" on LCD.
3. Rotate channel switch to choose desired setup.  
**50MS**: Each DTMF signal transmits 50ms, interval 50ms.  
**100MS**: Each DTMF signal transmits 100ms, interval 100ms.  
**200MS**: Each DTMF signal transmits 200ms, interval 200ms.  
**300MS**: Each DTMF signal transmits 300ms, interval 300ms.  
**500MS**: Each DTMF signal transmits 500ms, interval 500ms.
4. Press **D ESC** key or **# ENT** key to confirm and exit.



### ((( Squelch level setup

This function is used for setup intensity of receiving signals, transceiver will hear calls when receiving signal intensity achieve preset data, otherwise, transceiver will keep mute.

1. Press **[A FUNC]** key, the top left corner of LCD displays "✉" icon, then press **[8 SET]** key enter into function menu.
2. Press **[B MAIN]** / **[C V/M]** key to choose NO. 23 function item, it shows "SQL" on LCD.
3. Rotate channel switch to choose desired setup.  
**00~09**:10 levels of squelch in total for optional, "00" is minimum setup value (normally open)
4. Press **[D ESC]** key or **[# ENT ↵]** key to confirm and exit.



### ((( Scan Dwell Time Setup





There are three kinds of scan dwell time for optional.

1. Press **[A FUNC]** key, the top left corner of LCD displays "✉" icon, then press **[8 SET]** key enter into function menu.
2. Press **[B MAIN]** / **[C V/M]** key to choose NO. 24 function item, it shows "SCAN" on LCD.
3. Rotate channel switch to choose desired setup.  
**5ST**: When scanning matched signal, transceiver will stop scanning for 5seconds then resume.  
**10ST**: When scanning matched signal, transceiver will stop scanning for 10seconds then resume.  
**15ST**: When scanning matched signal, transceiver will stop scanning for 15seconds then resume.  
**2SP**: When scanning matched signal, transceiver will stop scanning, 2seconds after signal disappeared, then resume.
4. Press **[D ESC]** key or **[# ENT ↵]** key to confirm and exit.



## ○ FUNCTION MENU SETUP

### ((( Function Icon Stay Time Setup

1. Press  key, the top left corner of LCD displays "☑" icon, then press  key enter into function menu.
2. Press  /  key to choose NO. 25 function item, it shows "FTIME" on LCD.
3. Rotate channel switch to choose desired setup.

**FUNCT:** When finished function setting or enter into function menu, icon disappeared.

**1SEC:** When finished function setting or enter into function menu, icon stay 1second then disappeared.

**2SEC:** When finished function setting or enter into function menu, icon stay 2seconds then disappeared.

**3SEC:** When finished function setting or enter into function menu, icon stay 3seconds then disappeared.

**ALWAYS:** Function icon is always display, only when pressing function key again, the icon will disappear.

4. Press  key or  key to confirm and exit.



FTIME  
FUNCT 25







FTIME  
1SEC 25



FTIME  
ALWAYS 25

**NOTE:** When function icon is staying, user can setup desired functions continuously, no need press function key every time.

### ((( LCD Backlight Setup

1. Press  key, the top left corner of LCD displays "☑" icon, then press  key enter into function menu.
2. Press  /  key to choose NO. 26 function item, it shows "LIGHT" on LCD.
3. Rotate channel switch to choose desired setup.



LIGHT  
AUTO 26

## ○ FUNCTION MENU SETUP

**AUTO:** Backlight will automatic closed after a period.

**OFF:** Always off.

**ON:** Always on.

4. Press key or key to confirm and exit.



## ((( LCD Backlight Color Setup

There are three kinds of backlight color for optional.

1. Press key, the top left corner of LCD displays "✉" icon, then press key enter into function menu.
2. Press / key to choose NO. 27 function item, it shows "**COLOR**" on LCD.
3. Rotate channel switch to choose desired setup.

**BLUE:** Blue backlight.

**ORG:** Orange backlight.

**PUR:** Purple backlight.

4. Press key or key to confirm and exit.



## ((( Self ID inquiry

1. Press key, the top left corner of LCD displays "✉" icon, then press key enter into function menu.
2. Press / key to choose NO. 28 function item, it shows "**ID**" on LCD.
3. Rotate channel switch to choose desired setup.

The ID code displaying on LCD is transceiver self ID code.









## ○ FUNCTION MENU SETUP

4. Press  key or  key to confirm and exit.

**NOTE:** When current channel add 5TONE to be optional signaling, LCD displays 5TONE self ID code, otherwise displays DTMF self ID code.

### ☞ Tone Pulse Frequency Selection

This function is used for waking up sleeping repeater, it needs a certain intensity of Tone Pulse to wake up sleeping repeater. In general, as long as the repeater has been waked up, no need to transmit Tone Pulse again in preset time.





1. Press  key, the top left corner of LCD displays "☑" icon, then press  key enter into function menu.
2. Press  /  key to choose NO. 29 function item, it shows "TBST" on LCD.
3. Rotate channel switch to choose desired setup.  
1750Hz, 2100Hz, 1450Hz, 1000Hz, 4 kinds of Tone Pulse for optional.
4. Press  key or  key to confirm and exit.



TBST 29  
1750HZ

### ☞ Battery Save Setup

User can setup battery save ratio according to requirements. The standby time can be extended when enable battery save function, but if save ratio setting too high, it may cause voice missing.

1. Press  key, the top left corner of LCD displays "☑" icon, then press  key enter into function menu.
2. Press  /  key to choose NO. 30 function item, it shows "SAVE" on LCD.
3. Rotate channel switch to choose desired setup.  
**OFF:** Battery Save is disabled.



SAVE 30  
OFF

## ○ FUNCTION MENU SETUP

**1:2** The standby time between normal working state and battery saving mode is 1:2

**1:3** The standby time between normal working state and battery saving mode is 1:3

**1:5** The standby time between normal working state and battery saving mode is 1:5

**1:8** The standby time between normal working state and battery saving mode is 1:8

**AUTO:** Battery save ratio is adjusting automatically.



4. Press  key or  key to confirm and exit.

**Remind: When single band UHF or VHF in standby, proposed setup is 1:8, when dual band VV, UU or UV in standby, proposed setup is 1:2.**

## Ⓜ FM radio

1. Press  key, the top left corner of LCD displays "☑" icon, then press  key enter into function menu.

2. Press  /  key to choose NO. 31 function item, it shows "RADIO" on LCD.

3. Rotate channel switch to choose desired setup.

**ON:** FM radio function is enable.

**OFF:** FM radio function is disable.

4. Press  key or  key to confirm and exit.



**NOTE: Only when this function is setting ON, FM radio can be normally used.**

## Ⓜ FM Radio Functions

1. Press  to turn on FM Radio. Press again to turn off. ON/OFF cycle of radio will end FM Radio

## ○ FUNCTION MENU SETUP

- reception. Also when FM Radio is on, quick press of **[B MAIN]** key will mute / un-mute FM Radio.
2. FM Radio activates in either VFO Mode and Channel Mode. In Channel Mode, LCD shows received frequency with saved channel number to right hand side. In VFO Mode, only received frequency will show. Press **[C V/M]** to cycle between these two modes.
  3. Depending on mode, the keypad can be used to directly enter the number of a saved channel or the frequency of a desired FM Broadcast station.
  4. Depending on mode, rotating Selector Knob will step through saved channels or through VFO frequencies.
  5. Press **[A FUNC]** + **[S SCAN]** to scan VFO frequencies. Press **[D ESC]** to end scan when desired station is found.

### ((( PF1 key Function Setup

1. Press **[A FUNC]**, the top left corner of LCD display "  " icon, then press **[B SET]** key to enter into function menu.
2. Press **[B MAIN]** / **[C V/M]** to choose No.32 function item, it shows "PF1" on LCD.
3. Turn channel switch to choose desired setup.
  - VOLT:** Display current battery voltage.
  - CALL:** Calling.
  - ALARM:** Emergency alarm.
  - SUBPTT:** Sub band PTT.
  - FHSS:** Frequency Hopping ( for Version D only)
  - OFF:** Close the key function.
4. Press **[D ESC]** or **[# ENT]** to confirm and exit.





### ((( Display Mode Setup

There are three kinds of display modes for optional.

1. Press [PF2] key to turn on radio, hold [PF2] key until transceiver emits beep.
2. Press  key to choose No. 01 function item, it shows "DSP" on LCD.
3. Rotate channel switch to choose desired setup.

**FREQ:** Frequency + Channel mode, transceiver displays current channel name + frequency, press  key to switch into VFO mode.

**CH:** Channel mode, 1~22 items of function menu will hide automatically, user can only operate some functions. It is unable to switch into VFO by pressing  key. With this mode, radio can be used as commercial radio. When resume factory default, the display mode will be locked at CH mode, can not switch to FREQ or NAME mode by manually operation.

**NAME:** Channel + Name Tag mode, transceiver displays current channel number + channel name, press  key to switch into VFO mode.

4. Press  key or  key to confirm and exit.



### ((( Resume Factory Default

You can make all the settings of transceiver return to the factory default settings when transceiver can not work normally because of wrong operation or error setup.

1. Press [PF2] key to turn on radio, hold [PF2] key until transceiver emits beep.
2. Press  key to choose No. 02 function item, it shows "RESTOR" on LCD.
3. Rotate channel switch to choose desired setup.





## ◦ SENIOR FUNCTION OPERATIONS

**OFF:** No operations.

**FACT:** Resume all items to factory default, including channel and background settings.

**INIT:** Resume background settings to factory default, channel operations are keeping.

4. Press  key to exit current selection.
5. Press  key to confirm current selection.



## ((( Cloning Cable

This feature will copy the programmed data and parameters from the master unit to slave units. It copies the parameters and memory program settings.

Connection: Use optional CP04 cloning cable, connect Read / write frequency port on both master and slave, setting and programing as the requirement below.

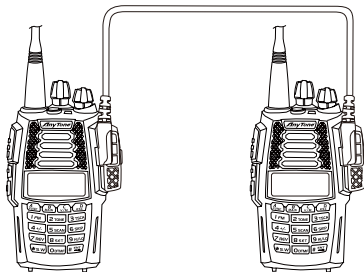

## o SENIOR FUNCTION OPERATIONS

[Settings: Master side]

1. Press the [PF1] side key to Power on, the display shows "**CLONE**", the master unit enters into copy mode.
2. Press [PF1] key, the display appears "**CLONE XX**" XX stands for the data amount being cloned.
3. When the data transfer is completed, slave unit restarts, the master unit display appears "**CLONE 04**".
4. Master unit remain copy mode state to prepare for the next copy, if reboot the master means exit copy mode to return to normal mode.



CLONE



CLONE  
A5



CLONE  
04

[Settings: Slave side]

1. In the standby mode, when the slave receives the data, the display shows "**CLONE XX**" XX stands for the data being cloned.
2. When data reception is complete, the slave unit returns to normal mode and restart automatically.
3. Turn off the slave's power, remove the cable, insert another slave which you want to copy.



CLONE  
A5

If the data is not successfully transmitted, turn off the master and slave, check if the cable connections are correct, and then repeat the whole process again.

## ◦ ADDITIONAL FUNCTIONS FOR VERSION C AND D

### ((( Cross-Band Repeater( Version C and D)





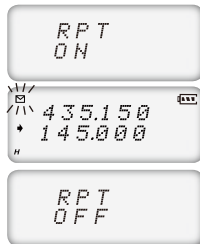

Radio will function as cross band repeater when in this mode.

1. Set Main-Band and Sub-Band to desired UHF and VHF frequencies.
2. Power radio off.
3. Press and hold both [PF1] and  while powering radio on.
4. LCD will show "RPT ON" and "✉" in top left corner will blink. Cross-band repeater function is on.
5. To exit Cross-Band Repeater, repeat Step 3. LCD will show "RPT OFF".



### ((( Sub-Radio Volume Setting( Version C and D)

When main band and sub band receive signal at the same time, the sub band volume can be adjusted to avoid confusion.

1. Press  key, LCD shows "✉" icon, then press  to enter into function menu.
2. Press  /  to choose No.32 (Version C) or No.35 (Version D) function item, it shows "SUBVOL" on LCD.
3. Turn channel knob to select your desired setting.  
Total is 8 volume levels for choice.
4. Press  or  to confirm and exit.



**NOTE: In Version C, Press  key to adjust sub-radio volume quickly.**

## 《《 Mute Setup (Version C and D)

In UV or VU mode, when one band is RX, the other band is TX, turn on this function will mute the speaker of RX band.

1. Press **[A FUNC]** key, LCD shows "✉" icon, then press **[8 SET]** key to enter into function menu.
2. Press **[B MAIN]** / **[C V/M]** key to choose No.34(Version C) / No.36(Version D) function item, LCD displays "MTUE".
3. Rotate channel switch to choose desired setup.  
**ON:** Mute RX when TX.  
**OFF:** Not mute RX when TX.
4. Press **[D ESC]** or **[# MRS]** key to confirm and exit.



## 《《 2TONE encode group selection (Version D)

1. Press **[A FUNC]** key, LCD shows "✉" icon, then press **[8 SET]** key to enter into function menu.
2. Press **[B MAIN]** / **[C V/M]** key to choose NO.04 function item, it shows "2T-ENC" on LCD.
3. Turn channel knob to choose desired 2TONE encode group.  
 CALL00~CALL31, 32 groups in total for optional.
4. Press [PTT] key to transmit selected 2TONE encode, press **[D ESC]** or **[# MRS]** key to confirm and exit.



## ◦ ADDITIONAL FUNCTIONS FOR VERSION C AND D

### ((( MSK encode group selection(Version D)

1. Press **A FUNC** key, LCD shows "✉" icon, then press **B SET** key to enter into function menu.
2. Press **B MAIN** / **C V/M** key to choose NO.06 function item, it shows "MSKENC" on LCD.
3. Turn channel knob to choose desired MSK encode group.  
CALL00~CALL31, 32 groups in total for optional.
4. Press [PTT] key to transmit selected MSK encode, press **D ESC** key or **# MSK →** key to confirm and exit.



MSKENC  
CALL00

### ((( Transmit MSK message (Version D)

1. In standby, press **# MSK →** key to enter into MSK message edit state, LCD shows "MSG".
2. Turn channel knob to choose desired message character.
3. Press [PF1] to enter into next character edition, press [PF2] to return last character edition. Or press key 0-9 to shift the cursor.
4. When finish edition, press **# MSK →** key, LCD shows "CAL ID", press **B MAIN** / **C V/M** key to choose different items.  
**CAL ID:** Send to single person  
**CAL AL:** Send to all.  
**CAL GR:** Send to group.
5. Enter the receiver's or group ID, then press **# MSK →** or [PTT] key to transmit.



"  
-MSG-  
-----



"  
CAL ID  
-----



"  
CAL AL  
-----







"  
CAL GR  
-----

### ((( Frequency Hopping (Version D)

When [PF1] key programmed as FHSS, press [PF1] key will turn on the frequency hopping function. When press [PTT] key, LCD shows "FHSS", radio will communicate in the preset frequency hopping range.

**Note: The receiver and transmitter must have same hopping frequency, and must setup the MSK decode. User can set up the hopping frequency in PC software ( default is 430MHz).**

### ((( AM/FM/SW/LW Band (Version D)

Version D has FM/AM/SW/LW total 4 FM radio bands. Press  key then press  key to turn on FM radio, later press  key then press  key to switch between FM/AM/SW/LW band, quickly press  key will mute /un-mute FM radio.

FM: 64~108MHz(RX)

AM: 118~136MHz(RX)

SW: 2.3~21.85MHz(RX)

LW: 0.52~1.71MHz(RX)

**Note: 1. To use FM radio function, the function menu No.34 RADIO must be set ON.  
2. AM/SW/LW require special antenna.  
3. When AM is on, the downside RX channel is occupied.**

## ○ Programming software starting (Takes Windows XP system for example)

1. Double Click "QPS398UV setup.exe", then go on installing as computer command.
2. Click "START" menu of computer, choose "USB To COM" in QPS398UV item and click it. Please install USB To Comport drive program as computer command.
3. Please plug PC03 programming cable into USB port of PC device, then connect to transceiver.
4. Double click "QPS398UV" shortcut icon, or click QPS398UV item in "START" menu to open programming software interface.
5. Choose "COM Port" as computer command, then click "OK" to start programming software.

**NOTE: In same computer, if programming cable plugs into different USB port, the COM Port number is different.**

Before programming, transceiver should be turned on firstly. Not turn on or turn off transceiver when it is connecting with computer, otherwise it may cause transceiver not read or write data. If this situation is happened, please shut down programming software, remove programming cable from computer, then re-plug cable into computer and re-start programming software, re-choose COM Port, the programming will work normally.

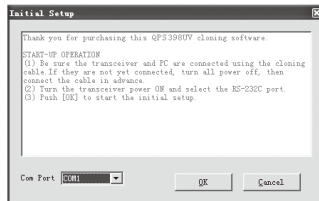

(picture 1)

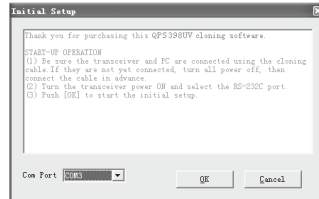

(picture 2)

### NOTE:

**The programming software is attached with product identifying system. In first time run, the transceiver should be connected to computer, otherwise the software can not run.**

## TECHNICAL SPECIFICATION

General	
Frequency Range	VHF: 144~146MHz (EX: 136~174MHz) UHF: 350~390MHz (Type: B only) UHF: 430~440MHz (EX: 400~480MHz)
Channel Capacity	200 channels
Channel Spacing	25KHz (wide band) 12.5KHz (narrow band)
Phase-locked Step	0.1KHz
Operation Voltage	7.4V DC $\pm$ 20%
Battery Life	More than 18 Hours(2200mAh), by 5-5-90 working cycle
Frequency Stability	$\pm$ 2.5ppm
Operation Temperature	-20°C ~ +55°C
Size	123×66×39mm (with battery)
Weight	285g (with battery, antenna, belt clip)

Receiving Part		
	Wide band	Narrow band
Sensitivity (12dB SINAD)	$\leq$ 0.25 $\mu$ V	$\leq$ 0.35 $\mu$ V
Adjacent Channel Selectivity	$\geq$ 65dB	$\geq$ 60dB
Intermodulation	$\geq$ 60dB	$\geq$ 60dB
Spurious Rejection	$\geq$ 70dB	$\geq$ 70dB
Hum & Noise	$\geq$ 45dB	$\geq$ 40dB
Audio Distortion	$\leq$ 5%	
Audio Power Output	1000mW/10%	

Transmitting Part		
	Wide band	Narrow band
Power Output	6W/1W (VHF ) 5W/1W (UHF )	
Modulation	16K $\Phi$ F3E	11K $\Phi$ F3E
Adjacent Channel Power	$\geq$ 65dB	$\geq$ 60dB
Hum & Noise	$\geq$ 40dB	$\geq$ 40dB
Spurious Emission	$\leq$ -36dB	$\leq$ -36dB
Audio Distortion	$\leq$ 5%	



## ◦ TROUBLE SHOOTING GUIDE

<b>Problem</b>	<b>Corrective Action</b>
No power	A.The battery may be exhausting. Recharge or replace the battery. B.The battery may not be installed correctly. Remove the battery and install it again. C.The power switch is broken; send it to local dealers to repair. D.Battery touch is broken; send it to local dealers to repair.
Battery power dies shortly after charging.	The battery life is finished. Replace the battery pack with a new one.
Transceiver cannot scan	The channels are not in scan list. (Professionals set it.)
All band noisy after programmed	Turn on squelch when programmed. Non-professionals are advised not rammmed to adjust this function.
No sound after using earphone. for a while	Earphone jack is broken. Please contact with local dealers to repair.
Communication distance becomes short, and Low sensitivity	A.Check whether the antenna is in good conduction and the antenna base do not come adrift. B.Antenna connector is broken or not or with sundries. Whether it has set in low power output. (Please contact with local dealers to repair.)
Cannot talk or hear other members in your group	A.Different frequency or channel, please change it. B.Different CTCSS / DCS / DTMF, please reset it. C.Out of communication range.

## ◦ TROUBLE SHOOTING GUIDE

Can not power on or frequent power off	Check weather the battery touch is out of sharp or broken.
The receiving sound gets low or intermittent	Check weather the MIC is stoppage. Otherwise, please contact with local dealers to repair it.
Receiving intermittent with in big noise	A.Out of communication range or obstruct by tall buildings or in big noise. B.450 filter is broken, Please contact with local dealers to repair.
Loudspeaker become lower or with"ka ka"sound after using a certain time	Check whether the loudspeaker is broken, Iron powder or sundries is in the loudspeaker. Please contact with local dealers to repair.
Receive voice from the other party but can not transmit	Check [PTT] key.
Receiving indicator with green light but no sound	A.Low volume, please clockwise to turn on. B.Loudspeaker is broken, please contact with local dealers to repair. C.Earphone jack is broken, please contact with local dealers to repair. D.Volume switch is broken.

## ◦ ATTACHED CHART

### ((( CTCSS Frequency Chart

1	62.5	12	94.8	23	136.5	34	177.3	45	218.1
2	67.0	13	97.4	24	141.3	35	179.9	46	225.7
3	69.3	14	100.0	25	146.2	36	183.5	47	229.1
4	71.9	15	103.5	26	151.4	37	186.2	48	233.6
5	74.4	16	107.2	27	156.7	38	189.9	49	241.8
6	77.0	17	110.9	28	159.8	39	192.8	50	250.3
7	79.7	18	114.8	29	162.2	40	196.6	51	254.1
8	82.5	19	118.8	30	165.5	41	199.5	52	user-defined
9	85.4	20	123.0	31	167.9	42	203.5		
10	88.5	21	127.3	32	171.3	43	206.5		
11	91.5	22	131.8	33	173.8	44	210.7		

## ◦ ATTACHED CHART

### (((1024 groups DCS frequency chart

000	001	002	003	004	005	006	007
010	011	012	013	014	015	016	017
020	021	022	023	024	025	026	027
030	031	032	033	034	035	036	037
040	041	042	043	044	045	046	047
050	051	052	053	054	055	056	057
060	061	062	063	064	065	066	067
070	071	072	073	074	075	076	077
100	101	102	103	104	105	106	107
110	111	112	113	114	115	116	117
120	121	122	123	124	125	126	127
130	131	132	133	134	135	136	137
140	141	142	143	144	145	146	147
150	151	152	153	154	155	156	157
160	161	162	163	164	165	166	167
170	171	172	173	174	175	176	177
200	201	202	203	204	205	206	207
210	211	212	213	214	215	216	217
220	221	222	223	224	225	226	227
230	231	232	233	234	235	236	237
240	241	242	243	244	245	246	247
250	251	252	253	254	255	256	257

## o ATTACHED CHART

260	261	262	263	264	265	266	267
270	271	272	273	274	275	276	277
300	301	302	303	304	305	306	307
310	311	312	313	314	315	316	317
320	321	322	323	324	325	326	327
330	331	332	333	334	335	336	337
340	341	342	343	344	345	346	347
350	351	352	353	354	355	356	357
360	361	362	363	364	365	366	367
370	371	372	373	374	375	376	377
400	401	402	403	404	405	406	407
410	411	412	413	414	415	416	417
420	421	422	423	424	425	426	427
430	431	432	433	434	435	436	437
440	441	442	443	444	445	446	447
450	451	452	453	454	455	456	457
460	461	462	463	464	465	466	467
470	471	472	473	474	475	476	477
500	501	502	503	504	505	506	507
510	511	512	513	514	515	516	517
520	521	522	523	524	525	526	527
530	531	532	533	534	535	536	537

## o ATTACHED CHART

540	541	542	543	544	545	546	547
550	551	552	553	554	555	556	557
560	561	562	563	564	565	566	567
570	571	572	573	574	575	576	577
600	601	602	603	604	605	606	607
610	611	612	613	614	615	616	617
620	621	622	623	624	625	626	627
630	631	632	633	634	635	636	637
640	641	642	643	644	645	646	647
650	651	652	653	654	655	656	657
660	661	662	663	664	665	666	667
670	671	672	673	674	675	676	677
700	701	702	703	704	705	706	707
710	711	712	713	714	715	716	717
720	721	722	723	724	725	726	727
730	731	732	733	734	735	736	737
740	741	742	743	744	745	746	747
750	751	752	753	754	755	756	757
760	761	762	763	764	765	766	767
770	771	772	773	774	775	776	777

**NOTE: N stands for positive code. I stands for inverted code. 1024 groups of DCS in total.**